

Maître d'Oeuvre :

Ginger CEBTP - AGENCE DE NANTES
Service Structure - Conception - Maitrise d'Oeuvre
24Q rue Jan Palach - ZAC des Hauts de Couëron 3
44220 COUERON
tel: 02 40 92 18 71



Maître d'Ouvrage :

VILLE DE LOIX
Mairie de Loix
Place du marché
17 111 Loix - Ile de Ré
tel : 05 46 29 01 06



Réhabilitation du pont de la Tonille
-
Ville de LOIX (17)
-
CAHIER DES PLANS PROJET

ONA5.J.0013.0002	PRO	2	-	-
RÉFÉRENCE GINGER	PHASE	INDICE	ECHELLES	FORMAT

Contient

Ouvrage existant :

- Vue en plan
- Coupe transversale

Ouvrage projeté :

- Vue en plan
- Coupes transversales
- Coupe longitudinale
- Elévation

Version	Date	Etabli par	Vérifié par	Modifications
1	09/02/22	C.GONZALEZ	C.DEFARD	Version initiale
2	17/02/22	C.GONZALEZ	C.DEFARD	MAJ v2

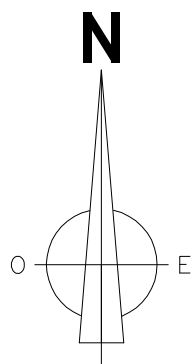
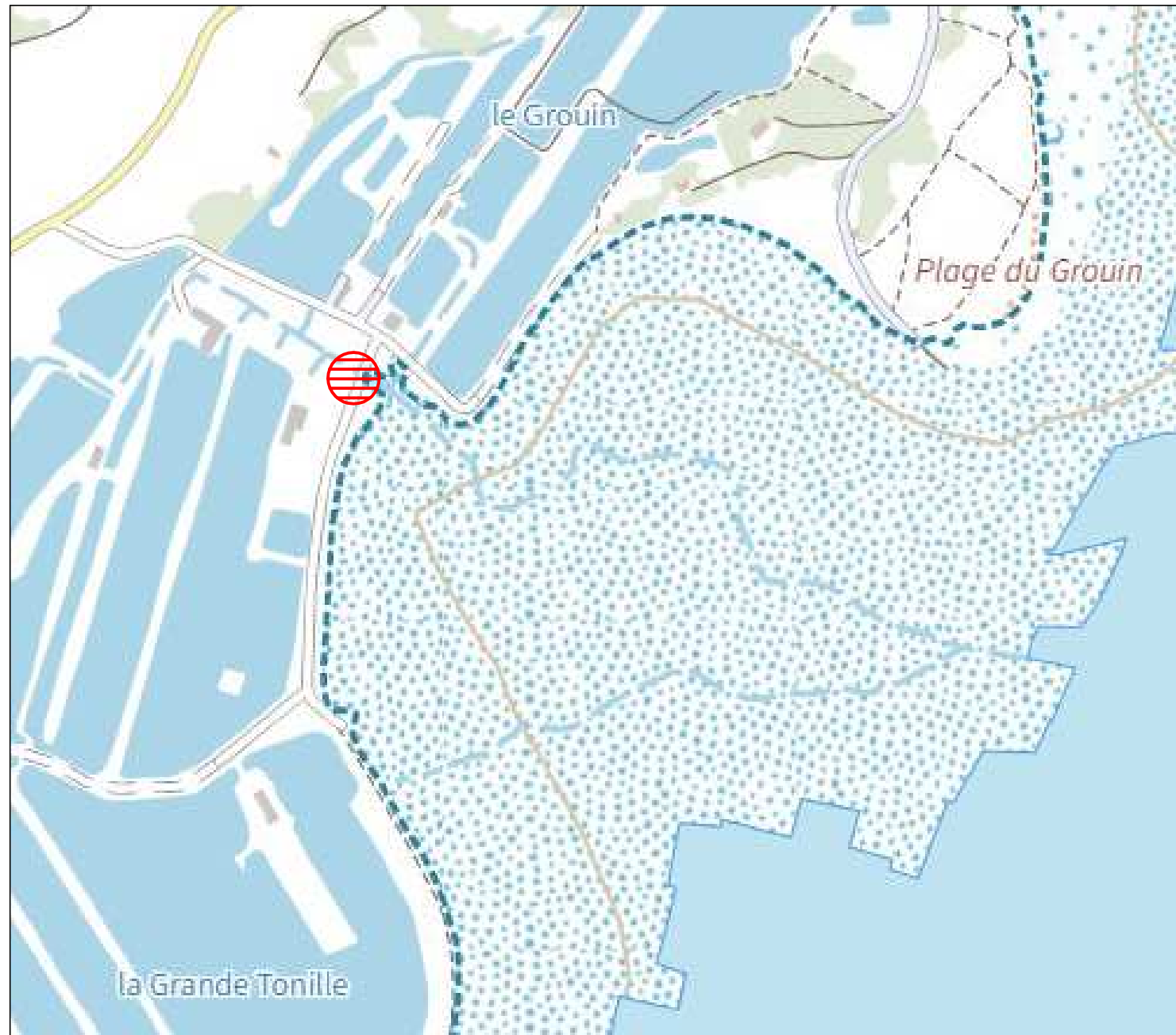

Plan de situation

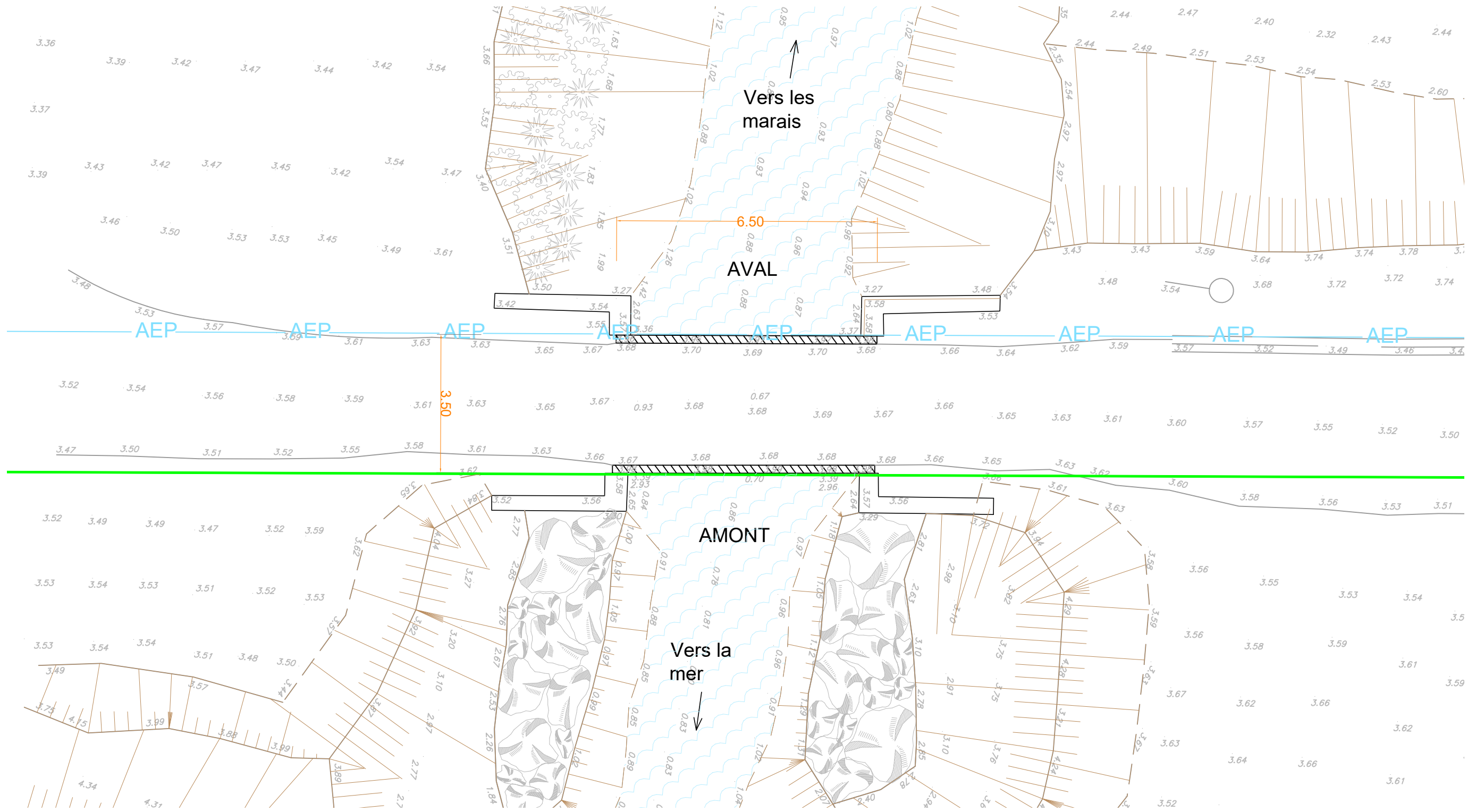

Dossier : ONA5.J.0013.0002	
Réhabilitation du pont de La Tonille LOIX (17) Phase PRO	
N° Plan : 1/8	Ginger CEBTP Agence de Nantes 23 Rue Jan Palach 44220 COUËRON
Plan de situation	
Date : 08/02/2022	

Ouvrage existant - Vue en plan

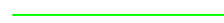

 Réseau Télécom existant
 Réseau Eau potable existant

Nota: Position hors ouvrage indicative

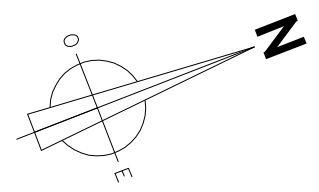

Dossier : ONA5.J.0013.0002		 GINGER CEBTP
Réhabilitation du pont de La Tonille LOIX (17) Phase : PRO		
N° Plan : 2/8	Ech: 1/100	
Ouvrage existant - Vue en plan Date : 08/02/2022		
		Ginger CEBTP Agence de Nantes 23 Rue Jan Palach 44220 COUËRON

Ouvrage existant - Coupe transversale

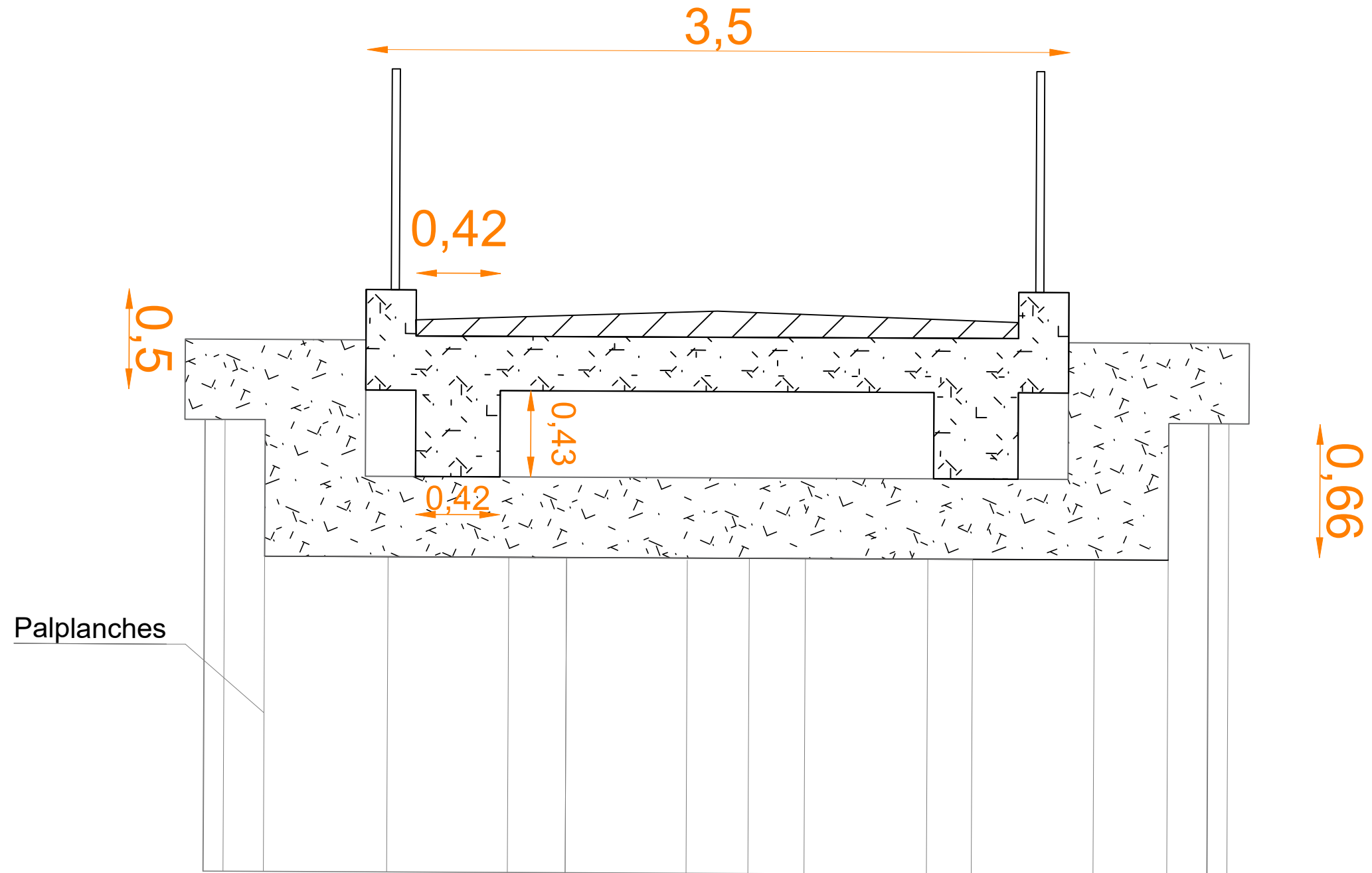

Dossier : ONA5.J.0013.0002	
Réhabilitation du pont de La Tonille LOIX (17) Phase : PRO	
	
N° Plan : 3/8	Ech: 1/25
Ouvrage existant - Coupe transversale	
Date : 08/02/2022	
Ginger CEBTP Agence de Nantes 23 Rue Jan Palach 44220 COUËRON	

Ouvrage projeté - Vue en plan

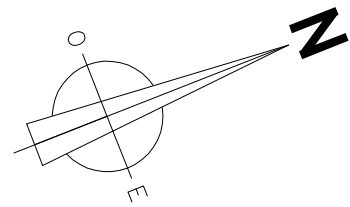
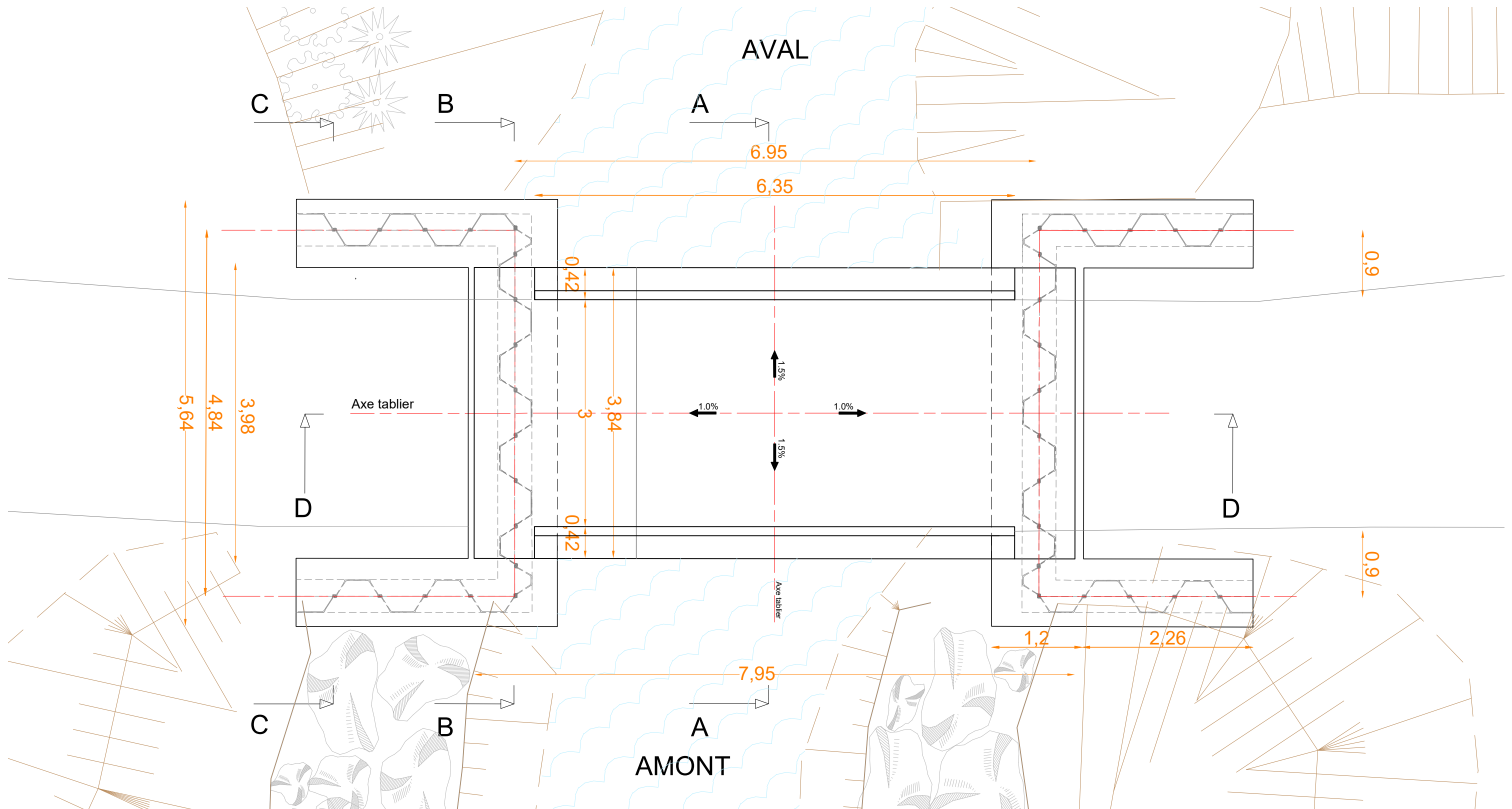

Dossier : ONA5.J.0013.0002		 GINGER CEBTP Ginger CEBTP Agence de Nantes 23 Rue Jan Palach 44220 COUËRON
Réhabilitation du pont de La Tonille LOIX (17) Phase : PRO		
N° Plan : 4/8	Ech: 1/50	
Ouvrage projeté - Vue en plan Date : 08/02/2022		

Ouvrage projeté - Coupe transversale

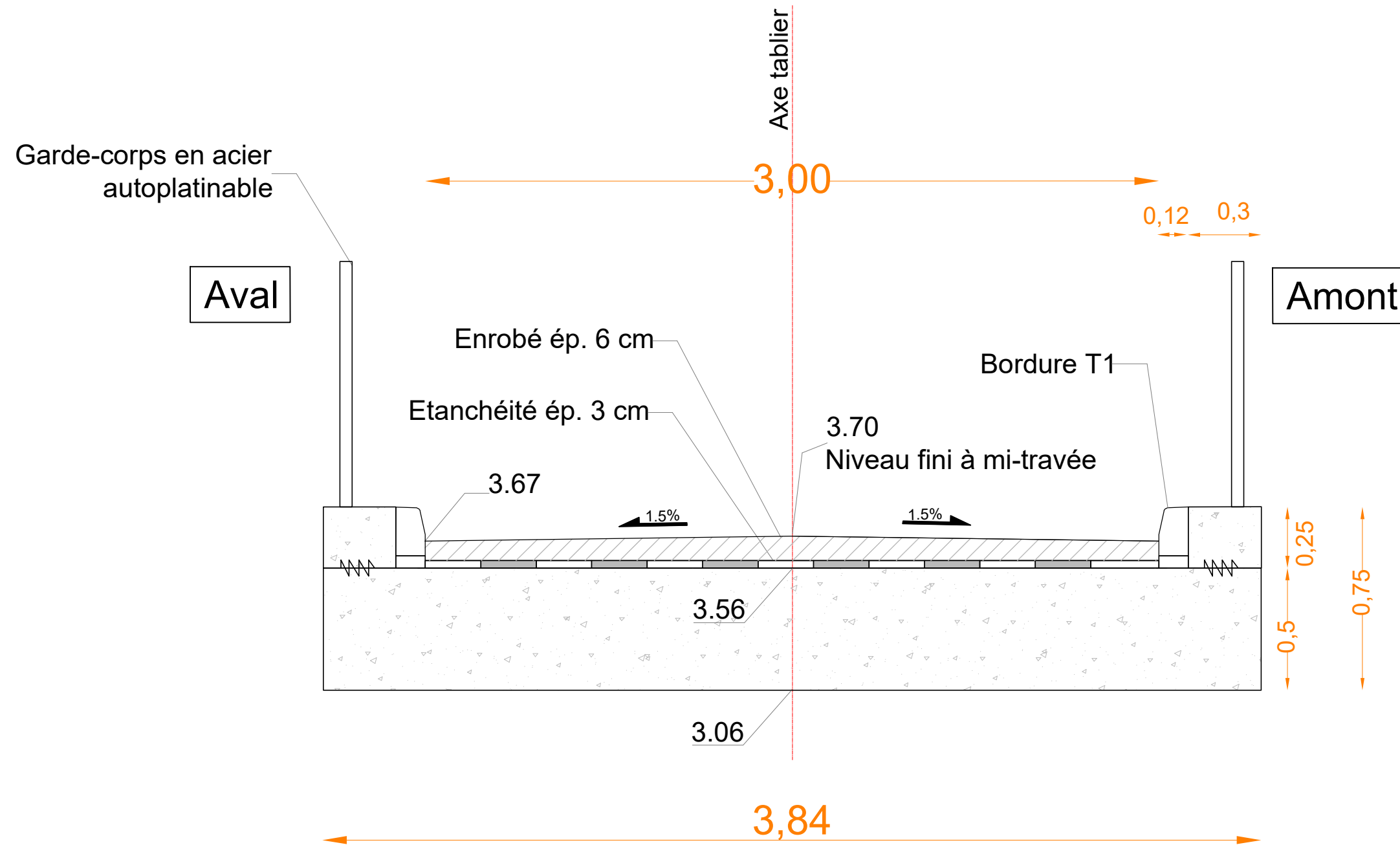

Coupe AA

Dossier : ONA5.J.0013.0002		
Réhabilitation du pont de La Tonille LOIX (17) Phase : PRO		
N° Plan : 5/8	Ech: 1/20	
Ouvrage projeté - Coupe transversale		Ginger CEBTP Agence de Nantes 23 Rue Jan Palach 44220 COUËRON
Date : 17/02/2022		

Ouvrage projeté - Coupes transversales

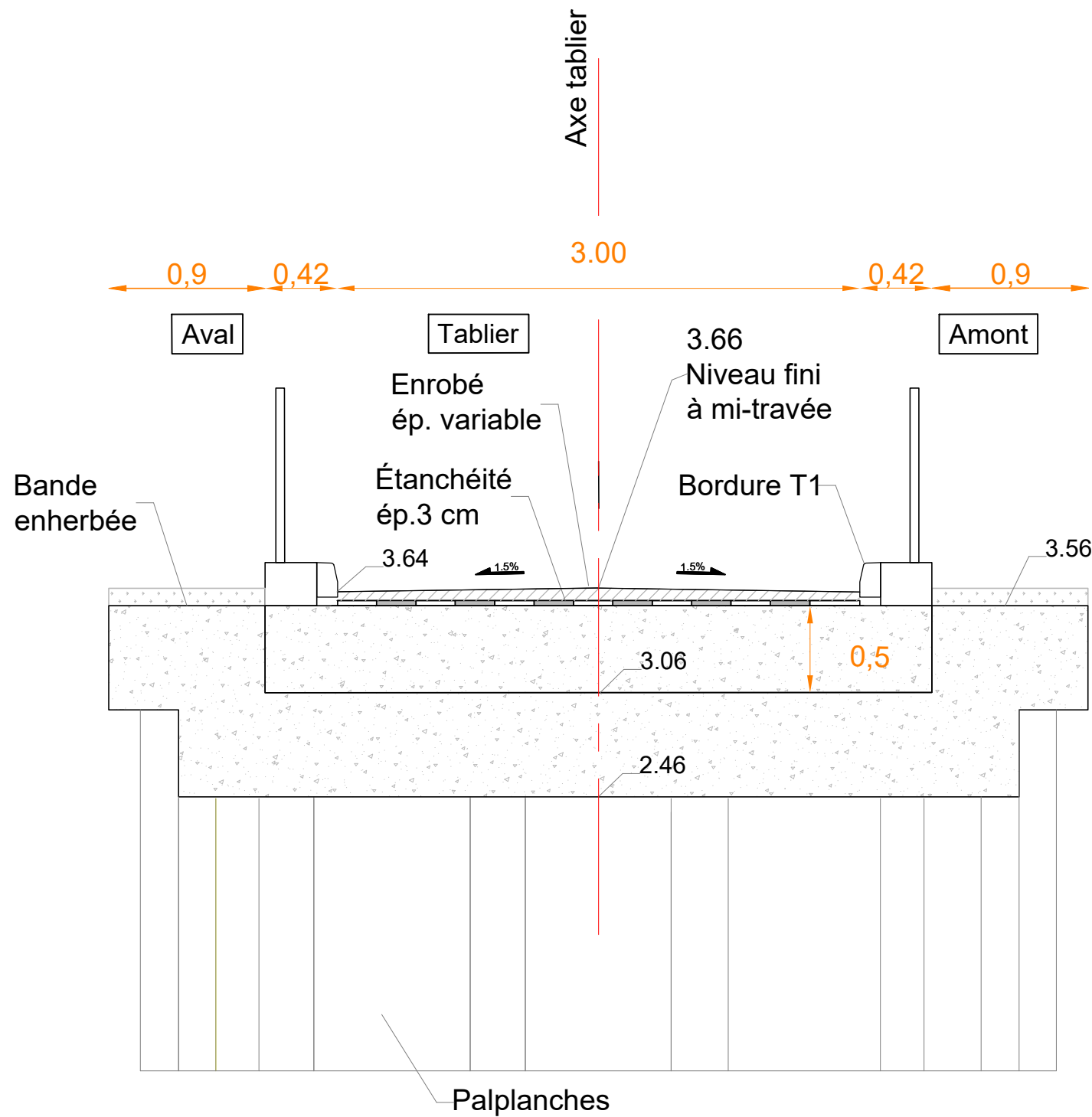

Coupe BB : Coupe au niveau de la culée

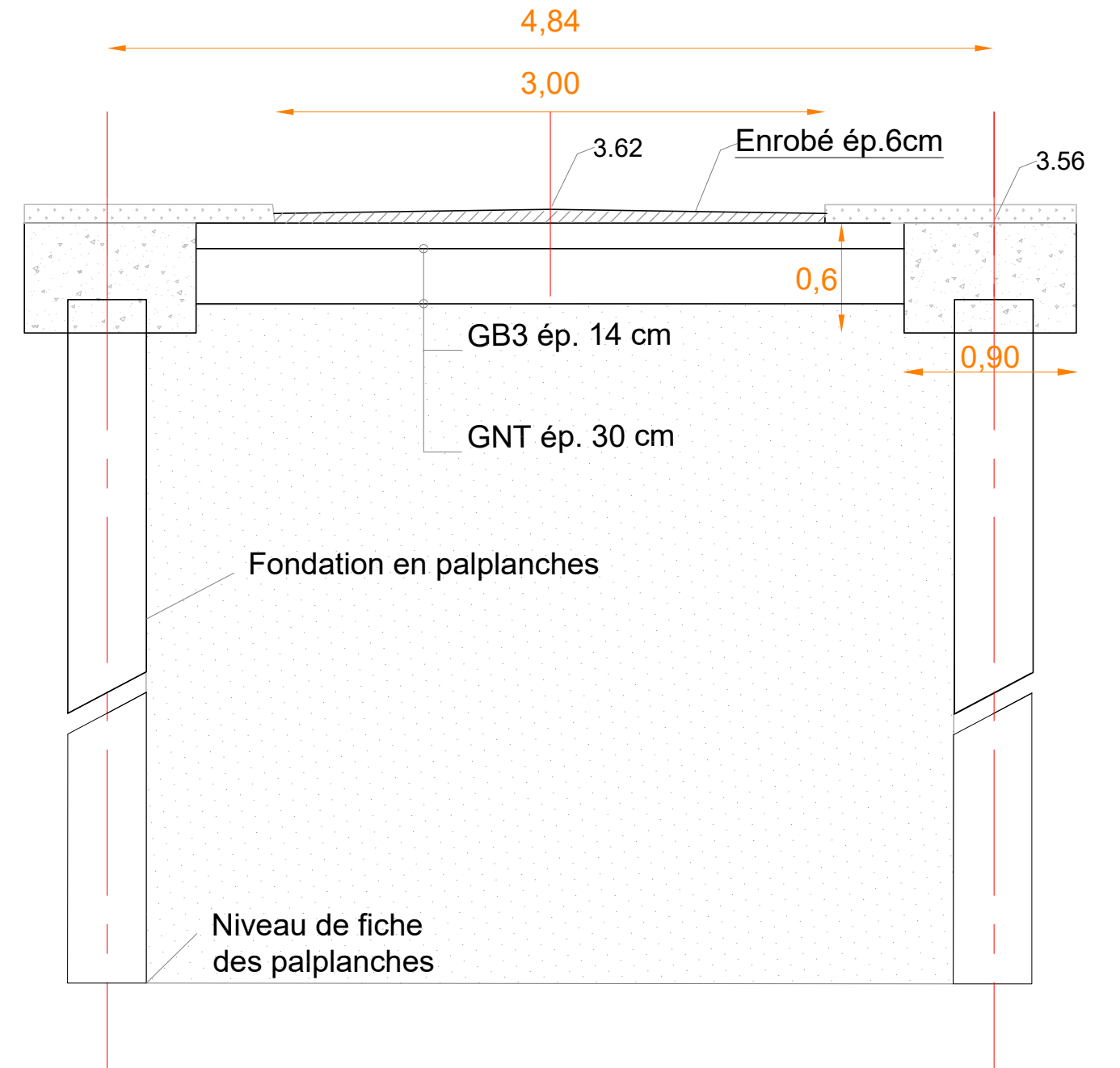

Coupe CC : Coupe au niveau des murs en retour

Dossier : ONA5.J.0013.0002		
Réhabilitation du pont de La Tonille LOIX (17) Phase : PRO		
N° Plan : 6/8	Ech: 1/33	Ginger CEBTP Agence de Nantes 23 Rue Jan Palach 44220 COUËRON
Ouvrage projeté - Coupes transversales		
Date : 17/02/2022		

Ouvrage projeté - Coupe longitudinale

Coupe DD

Ech. : 1/33

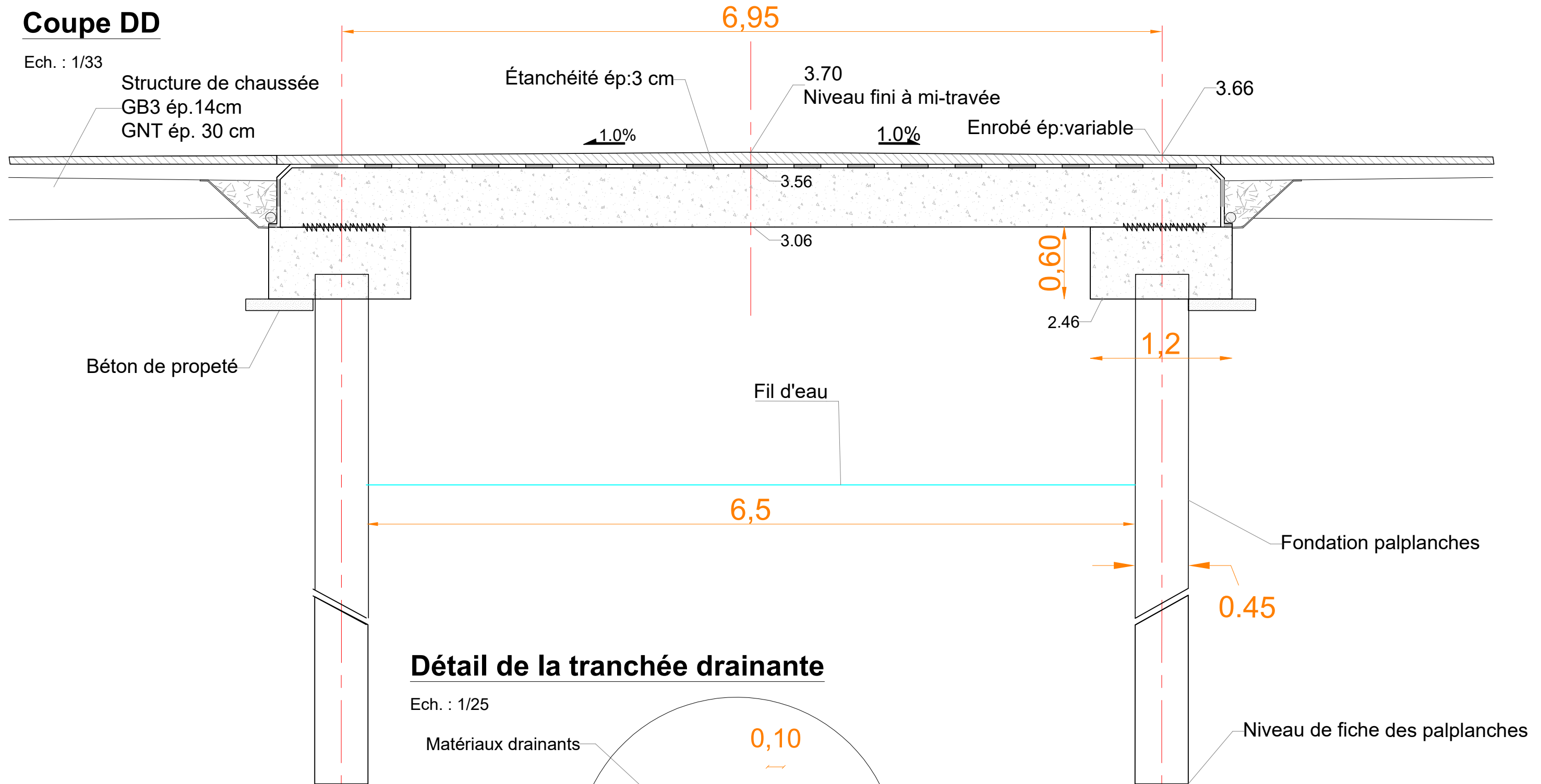

Détail de la tranchée drainante

Ech. : 1/25

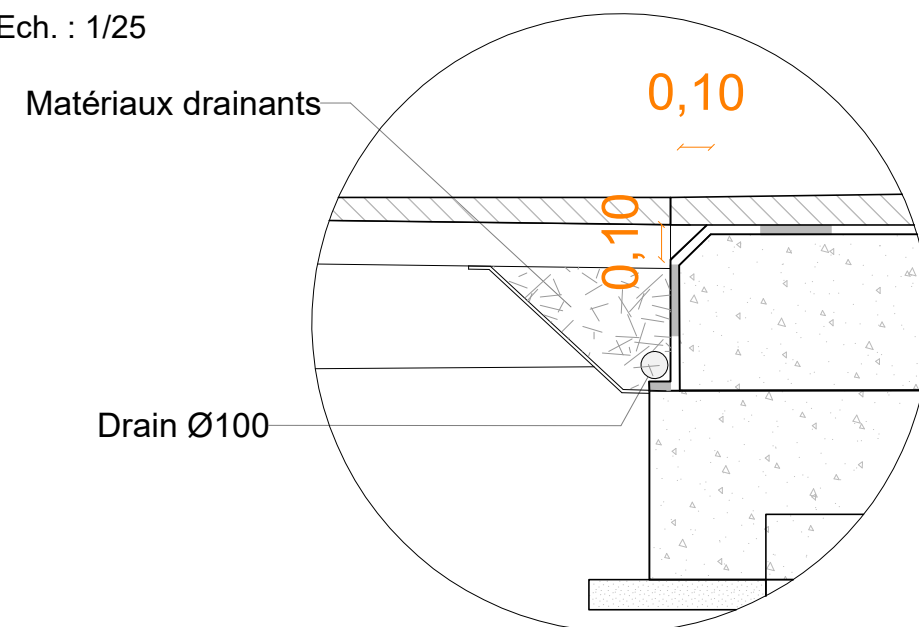

Dossier : ONA5.J.0013.0002		 Ginger CEBTP Agence de Nantes 23 Rue Jan Palach 44220 COUËRON
Réhabilitation du pont de La Tonille LOIX (17) Phase : PRO		
N° Plan : 7/8	Ech : 1/33 & 1/25	
Ouvrage projeté - Coupe longitudinale Date : 17/02/2022		

Ouvrage projeté - Élévation amont

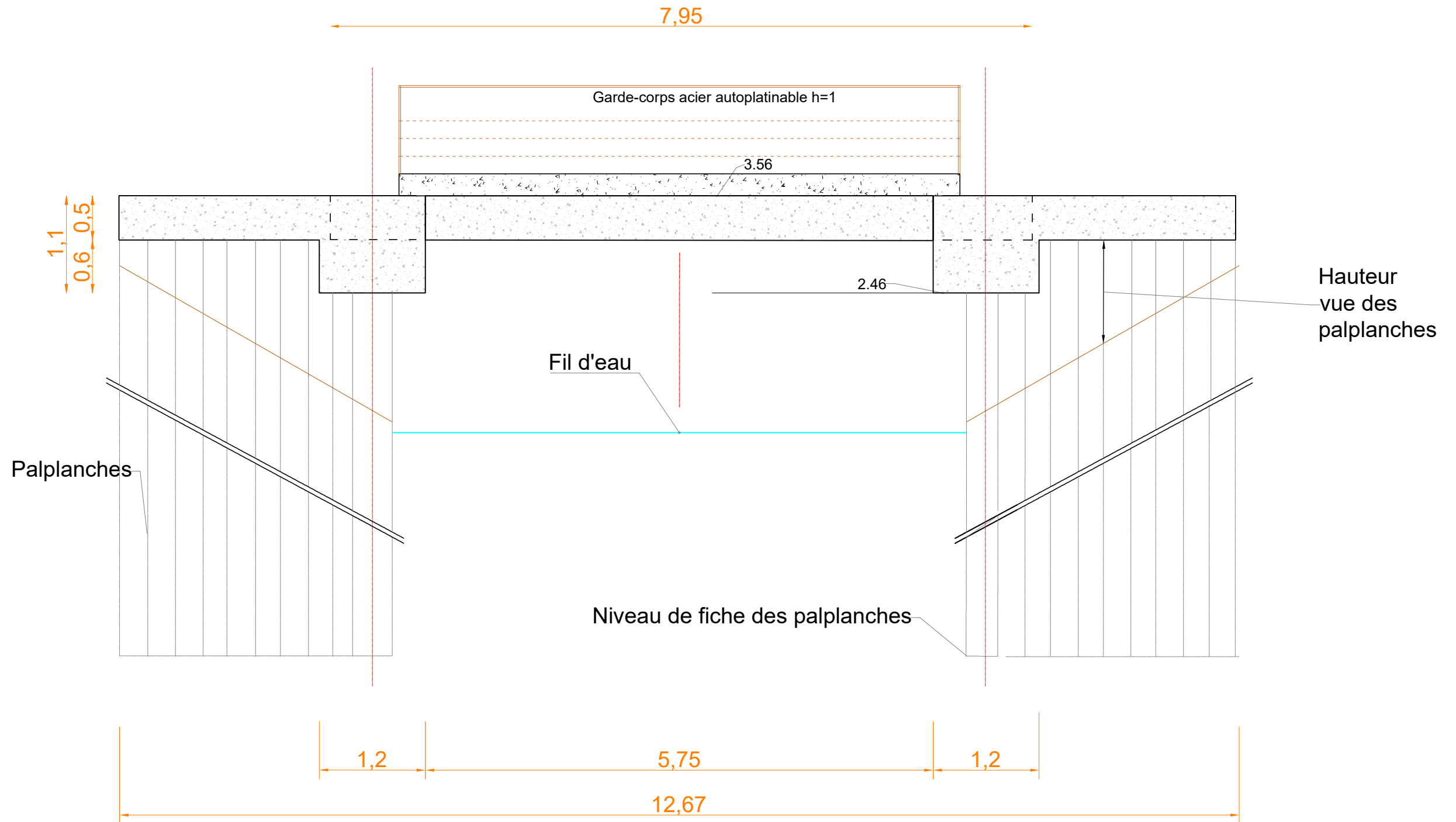

Dossier : ONA5.J.0013.0002		
Réhabilitation du pont de La Tonille LOIX (17) Phase : PRO		
N° Plan : 8/8	Ech: 1/50	Ginger CEBTP Agence de Nantes 23 Rue Jan Palach 44220 COUËRON
Ouvrage projeté - Élévation amont		
Date : 17/02/2022		